

microlene[®]

Installation and Operating Instructions

Aquashield MAX Packaged Ultra Violet Water Treatment System

Incorporating RainBank and Torrium2 Controllers,
Microlene Filters and Steriflo Disinfection



Minimum operating pressure is 0kPa. Installation on a flooded suction is recommended. Installation under vacuum is not advised, any damage to persons or associated equipment will not be covered under this guarantee.



Maximum operating pressure for stainless steel UV chambers is 850kPa (125 psi). If this pressure can be exceeded or if operating close to this pressure fit a suitable pressure limiting valve in the supply to the UV chamber or mains water line.



WARNING: The pump, controller & UV Chamber operate under pressure. Under no circumstances should they be disassembled unless the internal pressure of the unit has been relieved. Failure to observe this warning will expose persons to the possibility of personal injury and may result in damage to the system or other property.



Ultra Violet radiation is harmful to skin & eyes.
DO NOT LOOK AT UV LAMP WHILE LAMP IS OPERATING.



DO NOT DISASSEMBLE ANY COMPONENTS UNTIL YOU HAVE FULLY READ THESE INSTRUCTIONS!

Please pass these instructions on to the operator of this equipment.

Table of Contents

INTRODUCTION		Page 3
PREPARING YOUR SYSTEM		Page 4
Choosing a Site		Page 5
Power Connection		Page 5
Pipe Connections		Page 6
PUMP CONTROLLERS	– Torrium2	Page 7
	– RainBank	Page 9
PRE-TREATMENT – (FILTRATION)		Page 12
Steriflo – (DISINFECTION)		Page 13
Lamp Installation		Page 14
Operation		Page 15
Maintenance		Page 15
Water Quality		Page 16
Lamp Alarm System		Page 17
TROUBLE SHOOTING		Page 18

INTRODUCTION

Congratulations on your purchase of a high quality, award winning Aquashield MAX Ultra Violet water treatment system.

Aquashield MAX represents advances in safety and convenience of rainwater harvesting technology for rainwater users. The range offers increased water treatment quality and safety - producing water that is biologically safe to drink, without the use of chemicals.

This all in one unit is pre fitted with a correctly matched pump, Microlene cartridges and housings and Steriflo units and can come with either the Rainbank or the Torrium2 pump controller.

Applications: Pressure boosting and disinfection of rainwater for:

- School shower and toilet blocks
- Commercial toilet flushing
- Large home potable water supply
- Industry process water treatment
- Guest house potable water supply
- Bacteria and algae growth control for aquaculture and water features
- Also suitable for bore and surface water treatment – *subject to a water quality test

Features & Benefits:

- Factory matched and tested package – ensures correct UV dosage and high reliability
- Pump interlock detects lamp failure and locks pump out– ensures only disinfected water is delivered
- Lamp count down timer with set limit of 9000 hours - ensures only disinfected water is delivered
- Durable UV resistant cover – allows for flexible, vandal resistant exterior installation
- RainBank controller options – provides seamless automatic mains water backup
- Torrium2 controller options – intelligent automatic pump control maximizes pump efficiency by adjusting run on time and cut in pressures
- 2 x 20” Jumbo cartridge filter housings – for low friction losses and long cleaning intervals
- 20 micron filtration – for long cleaning intervals and dirt, rust, sediment and debris reduction
- 1 micron filtration – for parasitic cyst reduction and high UV dosage rates

PREPARING YOUR SYSTEM

Your new Aquashield MAX system incorporates a lamp failure system design feature that enables you to be warned of a lamp failure by :-

1. A lamp failure LED
2. An audible alarm
3. Remote alarm contacts
4. Pump lock out feature

In addition when the alarm “beeps” on and off, the lamp is due to be changed so effective treatment is maintained.



Before installing your new Aquashield MAX please read all instructions carefully as failures caused by incorrect installation or operation are not covered by the guarantee. Your Ultra Violet water treatment system is designed to handle clean water. The system should not be used for any other purpose without specific referral to Davey Water Products. The use of the system with flammable, corrosive and other materials of a hazardous nature is specifically excluded.



DO NOT DISASSEMBLE ANY COMPONENTS UNTIL YOU HAVE FULLY READ THESE INSTRUCTIONS!

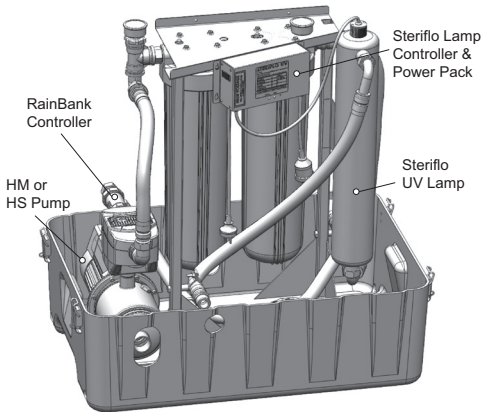

Aquashield®MAX
with RainBank®

Aquashield®MAX
with Torrium®2

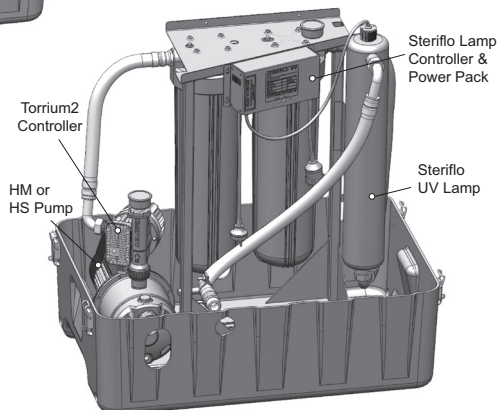

Prior to using this system you must ensure that:

- The system is installed in a safe and dry environment
- The system enclosure has adequate drainage in the event of leakage
- Any transport plugs are removed
- The pipe-work is correctly sealed and supported
- The pump is primed correctly
- The power supply is correctly connected
- All steps have been taken for safe operation

CHOOSING A SITE

Choose a site with a firm mounting position. Allow room for removal of the cover, lamp and sleeve during servicing. Leave a chamber lengths space above the lamp cover and connector end for lamp removal.

To protect your system from the weather, make sure the site is flood proof, water proof, frost free and has adequate ventilation. Allow for drainage, to avoid damage due to flooding etc., that over time may occur from leaking pipe joints or seals.



WARNING: Some insects, such as small ants, find electrical devices attractive for various reasons. If your site or enclosure is susceptible to insect infestation you should implement a suitable pest control plan.

POWER CONNECTION



WARNING: When servicing or attending your Aquashield MAX, always ensure power is switched off and lead unplugged. Electrical connections should be serviced only by qualified persons. If the electrical supply lead of this system is damaged, it must only be replaced by qualified service personnel.

Connect lead to power supply designated on the Steriflo control box label. Check that the earth is connected to the stainless steel chambers using bolt provided on the chamber. Plug the power lead for the pump into the lead hanging from the Steriflo control box.



The Steriflo control box has a red LED alarm indicator light mounted on its front panel, adjacent to the amber “power on” LED. This light will be illuminated whenever the Steriflo control box senses no lamp current. There is also an audible alarm in the event of lamp failure. The LED and/or alarm will only work when unit is connected to the correct electrical supply.



NOTE:

- a) For protection, the Davey pump motor is fitted with an automatic “over temperature” cut-out. Constant tripping of this overload device indicates a problem e.g. low voltage at pump, excessive ambient temperature (above 50°C) in pump enclosure.
- b) The Torrium2 control device may have to be reset after rectifying any of the above operating troubles. This is done by pushing in the “prime” button and releasing it after 2 seconds, or switching the power supply off then on.



This appliance is not intended for use by persons (including children) with reduced physical, sensory or mental capabilities, or lack of experience and knowledge, unless they have been given supervision or instruction concerning use of the appliance by a person responsible for their safety.

Electrical Power Surge Protection

An electrical power surge or spike can travel on the supply lines and cause serious damage to your electrical equipment. The Steriflo control box has a 2 Amp fuse to protect the circuit. The fuse is not a lightning arrester and may not protect the Steriflo if lightning or a very powerful surge hits the unit.

If the installation is subject to electrical power surges or lightning we strongly recommend the use of suitable additional surge protection devices on ALL electrical equipment.

We recommend the use of an RCD or earth leakage circuit breaker on the power supply to your unit.



**Ultra violet radiation is harmful to skin & eyes.
DO NOT LOOK AT UV LAMP WHILE LAMP IS OPERATING.**



DO NOT DISASSEMBLE ANY COMPONENTS UNTIL YOU HAVE FULLY READ THESE INSTRUCTIONS!

PIPE CONNECTIONS



NOTE: Prior to installation remove the transport plugs from the inlet, outlet and lamp end cap.

For best performance use P.V.C. or polythene pipes at least the same diameter as the pump's inlet opening. Larger diameter pipe may be used to minimise resistance to flow when pumping longer distances.

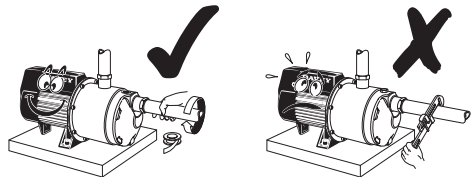



Do not use pipe thread sealing compounds on any part of this pump. ONLY use Teflon sealing tape.

To prevent strain on unit threads always support heavy inlet pipes.



NOTE: Suction leaks are the largest cause of poor pump performance and are difficult to detect. Ensure all connections are completely sealed using thread tape only.



RainBank controllers can only be connected to mains water, by a qualified licensed plumber.

PUMP CONTROLLERS

Option 1 – Torrium2

Your new system incorporates 'Torrium2', electronic flow controller – a Davey designed unit that enables the use of a highly efficient pump design and offers the following benefits:–

1. Enables the pump to deliver a constant flow of water particularly at low flow rates – reducing the inconvenience of pressure variation in showers etc.
2. Provides automatic “cut-out” protection should the pump run out of water or overheat*.
3. Provides warning indications for critical and noncritical system faults.
4. Has adaptive pressure cut-in which allows the pump to start at approximately 80% of the maximum pressure at last shut-down. This allows the controller to accommodate varying inlet pressures and pump performance.
5. Automatic retry functions in the event of a critical system fault.

* Motor overload / overheat protection included. Motor has its own overload / overheat protection.



The Davey Torrium2 fitted to this pump has a status indicator light mounted on its front panel. This light will be illuminated whenever the Torrium2 senses that there is electrical power available. The light will only work when unit is connected to the correct electrical supply.



The electrical connections and checks must be made by a qualified electrician and comply with applicable local standards.

Status Indicator

The Torrium2 has a status indicator light on the front panel. This light will enable you to understand what your pump is doing.

Condition	Indicator readout	Pump operation	Restart / Reset Method
Standby mode	Red light	Standby	Pressure drop
Running	Green light	Running	N/A
Fault	Yellow light	Stops, auto-retry & 'water return' activated	Push 'Prime' button or cycle power off / on



Only one fault condition will be indicated at once.

Auto-retry and Water Return Modes

Should your Torrium2 detect a loss of prime, after stopping the pump, it will wait five minutes before activating Auto-retry and Water Return modes. Auto-retry automatically starts the pump to see if the pump is now primed. It does this after 5 mins, 30 mins, 1 hr, 2 hrs, 8 hrs, 16 hrs and 32 hrs. Water return mode will restart the pump automatically if the Torrium2 detects water flow through it.

Priming and Operation

The Torrium2 module fitted to your HM or HS system is provided with a push button “Prime” button. This button is used during initial priming of the pump and also acts as a reset button if the Torrium2 switches out in pump protection mode.

1. Remove priming plug and fill casing and suction line (on flooded suction, simply open gate valve to pump). When full, replace priming plug.

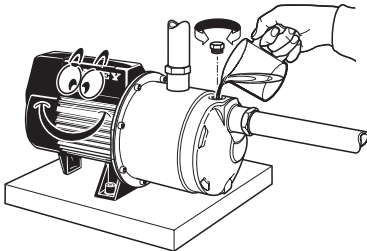

2. Ensure outlet nearest to pump is open.



3. Ensure all valves in suction line are open.

4. Switch on power - The status indicator light will be illuminated green and the pump will run. A full flow of water should be discharged from the open tap.

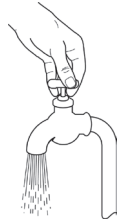

5. If the pump stops with the tap open see troubleshooting checklist.
6. Close the open outlet or tap and the pump should stop after a few seconds (the status indicator light should be illuminated red (constant). If not, consult the troubleshooting checklist.

To reset if pump switches out in Pump Protection Mode

1. Make sure pump is primed.
2. Open tap, push prime button.
3. Close tap and pump will stop.

Option 2 – RainBank – HOW IT WORKS

1. When there is demand for water from your toilet, washing machine or garden tap RainBank senses this demand and checks the level of water in the rainwater tank. Note: demand must be greater than 1.5 litres per minute or mains water will be delivered.
2. If there is rainwater in the tank RainBank switches on the pump. The pressure of the pump is sufficient to overcome the pressure of the mains water inside RainBank and this closes a dual check valve and allows the rainwater to flow.
3. When there is no longer a demand for water, RainBank detects that water has ceased to move inside the pipes, switches off the pump and waits for another water demand.
4. If RainBank senses a water demand and detects insufficient water in the rainwater tank it will automatically allow the mains water to flow.
5. If there is a power failure during a demand for water RainBank will automatically supply the mains water as backup.

Fit top entry float switch to rainwater tank

NOTE: THE VERTICAL POSITION OF THE FLOAT SWITCH IN RELATION TO THE PUMP WATER INLET IS CRITICAL

1. Measure the distance from the top of the tank (A) to the highest point of the tank outlet to the pump (B).
2. Mark on the float switch cable a length equal to A-B minus 200 millimeters or distance (B) to (D).
3. Drill a hole in the top of the tank large enough to suit a cable grommet or strain relief grommet (F) - not supplied.
4. Snap off retainer clip (C) from top of weight (D).
5. Position retainer clip 100mm from float ball (E).
6. Slide weight (E) over retaining clip and firmly snap into position.
7. Lower weight into tank and feed top of cable through hole drilled in Step 3.
8. Fasten with cable grommet to previously measured length (A) to (B).

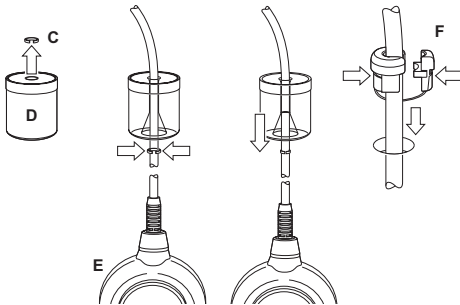

Above ground tank

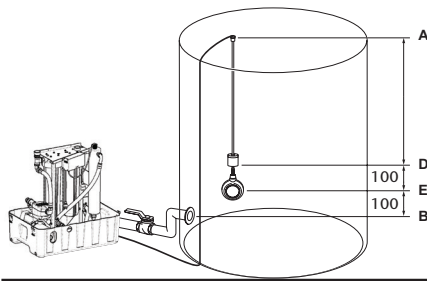

Underground tank

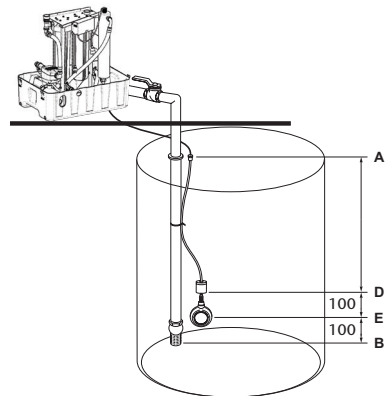



IMPORTANT: To allow easy connection it is strongly recommended that you have flexible copper pipes that allow some movement so that they can line up exactly with the mains water and rainwater outlet. These pipes must be 3/4 inch in diameter.



IMPORTANT: It is highly recommended that an isolation valve be fitted to where the mains water enters RainBank® and between the pump and the rainwater tank. This facilitates easy removal of the unit if required without turning off the household water or losing stored rainwater.

Test the operation of RainBank®.

1. With the mains connected and the rainwater tank empty turn on one of the taps in the laundry that feeds the washing machine or flush the toilet. Mains water should flow normally. The pump should not turn on. When this is completed turn off tap.
2. Fill the rainwater tank with sufficient water to activate or cover the float switch.
3. Check that the pump is correctly primed and there are no air locks that will interfere with its operation as per the Davey instructions. This is essential for the proper operation of the unit.
4. Turn on a tap or flush a toilet in the rainwater system. The pump should run and deliver rainwater. Allow to run for several minutes to clear air from pipes.
5. Remove the float switch connection from the RainBank® – this should stop the pump and confirms that the float switch and power connections have been made correctly - refit the float switch connection. Press the manual override button to operate the pump if needed.
6. Check for leaks around RainBank®, the pump, pipework and fittings.



NOTE: Do not install additional suction check valves on RainBank® systems except where a foot valve is required (eg. suction lift installations). In the case of suction lifts, to allow for the correct operation of your RainBank® and for movement of the tank and pump which may occur over time, the suction pipe must have a length of flexible suction hose from pump to top of tank. This hose can be braided hose, reinforced suction hose or polythene pipe at least 1 metre in length.

PRE-TREATMENT (FILTRATION)

This unit includes two-stage filtration. The first stage is a 20 micron filter to remove sediment, rust and grit. The second stage is a 1 micron filter to remove fine particles and cysts. Both of these filters help ensure that particulate matter does not shield micro-organisms from the UV light.

Temperature Rating

Maximum 50°C - Minimum 8°C



Caution: The housing must be protected against freezing. Failure to do so may result in cracking of the housing and water leakage.



WARNING: CAREFULLY AND GENTLY TIGHTEN WITH HOUSING SPANNER as the bowl should only be tightened enough to avoid water leaking during operation.



WARNING: If the water system is not going to be used for extended periods, the cartridge should be removed from the housing and replaced with a new or cleaned cartridge when the system is used again.

Sediment Cartridge Filter Life

Once the housing is properly installed, a reduction in flow/pressure (to such an extent as to cause inconvenience) will indicate when the cartridge is becoming clogged and needs replacing/cleaning. Sediment cartridges should be replaced/cleaned/sanitised when the water flow has been noticeably reduced or after 3-6 months - whichever comes first (this is for hygiene reasons).



NOTE: Actual filtration/purification life of cartridge can vary with the condition of incoming water.



NOTE: Clean filter Stage 1 once a pressure drop of 100 to 150kPa from clean occurs between Stages 1 and 2.

Changing the Filter Cartridge

1. Turn off the valve to stop the flow of water.
2. Release the pressure by opening a tap downstream, or use the pressure relief valve that is available in the lid of the filter housings.
3. Unscrew the bottom housing from the lid and pull out the used cartridge and discard or wash. The inside of the filter housing and the lid should be checked for cleanliness - they will usually need to be cleaned or sanitised - use hot water and dishwashing liquid, thoroughly scrub all surfaces and then rinse.
4. Check that the o-ring is in position in the top of the housing base, lubricate with a coating of white petroleum jelly (Vaseline), place the o-ring into the groove and with two fingers wipe the o-ring down into the groove. Do not wipe the o-ring clean of lubricant after it has been properly seated

in the groove because the lubricant prevents “crawling” of the o-ring during the tightening of the lid and thus prevents water leaks.

5. Screw the housing onto the lid and hand tighten. Open the tap downstream of the filter and then open the inlet valve.



IMPORTANT: When opening the filter housing to install or change the cartridge (element) it is common for the o-ring seal to lift out of the groove and, at times, it may even stick to the cap.



CAUTION WHEN INSTALLING

1. This is a plastic product with a female thread. If you cross-thread a male fitting, and/or you over pack with sealing tape, you could do permanent damage.
2. If you use a tapered thread male fitting do not over tighten.
3. No warranty claims will be considered for damage due to incorrect installation.

Steriflo

Your new Steriflo system incorporates a lamp failure system design feature that enables you to be warned of a lamp failure by :-

1. A lamp failure LED
2. An audible alarm
3. Remote alarm contacts

In addition when the alarm “beeps” on and off, the lamp is due to be changed so that effective treatment is maintained.

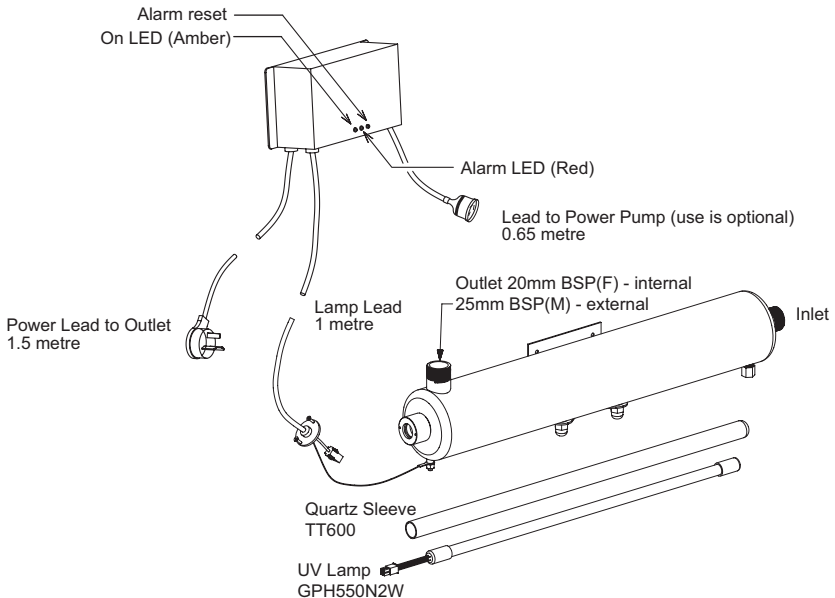

Connect lead to power supply designated on control box label. Check that the earth is connected to the stainless steel chambers using bolt provided on the chamber.



CAUTION: The supply cord is necessary for lamp changing. The three pin supply plug must remain accessible after installation. If installed to fixed wiring without the plug a two pole switch must be fitted and its ON and OFF positions shall be marked.



The Steriflo control box has a red LED alarm indicator light mounted on its front panel, adjacent to the amber “power on” LED. This light will be illuminated whenever the Steriflo control box senses no lamp current. There is also an audible alarm in the event of lamp failure. The LED and/or alarm will only work when unit is connected to the correct electrical supply.

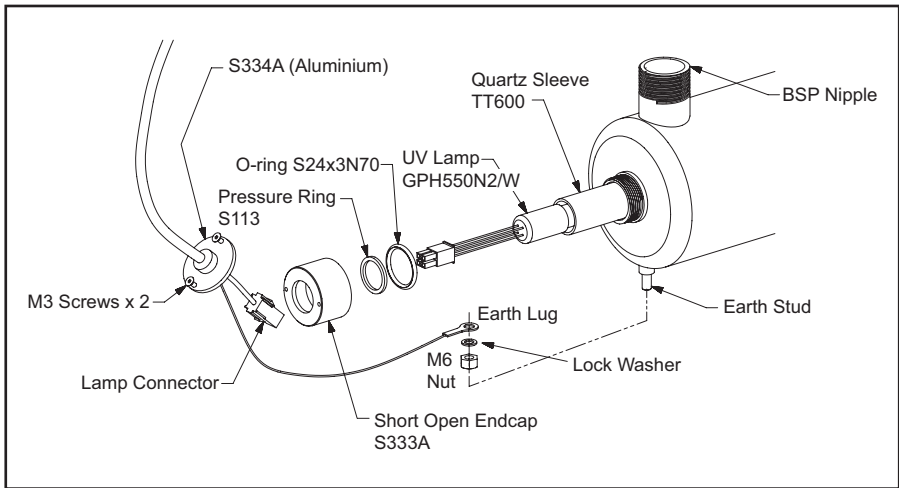

LAMP INSTALLATION

The Quartz Sleeve is pre-installed in the treatment chamber, and provided the endcap has not been disturbed or undone, is able to withstand well in excess of the maximum operating pressures.

Expose the connection end of the lamp from its transport tube and protective wrapping. The lamp connection socket is “keyed” to ensure correct alignment. Carefully remove the tube fully from its transport tube, touching the lamp as little as possible. Handle the lamp by the ends where possible. Wipe with clean cloth and methylated spirits if fingerprints or dirt need removing.

Slide the lamp into the chamber, fit lamp connection socket and then fasten the end washer into the endcap, with the screws provided.

OPERATION

Open valves and allow water to fill the chamber. Connect three pin plug to outlet and switch on. The “Mains On” Amber LED will be illuminated and the red alarm light will flash slowly.

Ensure the reset button is pressed and held for approx. 10 seconds. The unit should beep to indicate the lamp life timer has been reset. The timer will then count down for a further 12 months and the alarm will beep when the lamp needs to be replaced.

Allow two minutes for the UV lamp to reach full intensity before starting water flow.

Full lamp performance for a new installation will be achieved in 24 hours. On a new installation where no other form of sterilisation has been in constant usage, we recommend flushing the pipework with a suitable sanitiser such as Acquasafe.

The Acquasafe solution can be dosed to the water tank or if necessary added as a shot dose to the bowl of any filter housing installed with the UV system and slowly flushed into the piping.

If dosed to the water tank the Acquasafe will remain in the water. It is tasteless, odourless and suitable for use in drinking water.

Davey Water Products Pty Ltd can not accept responsibility for loss or damage resulting from incorrect or unauthorised installations.

MAINTENANCE

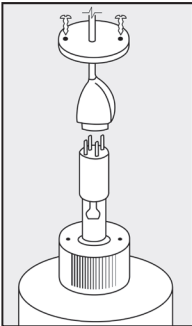

Lamp removal

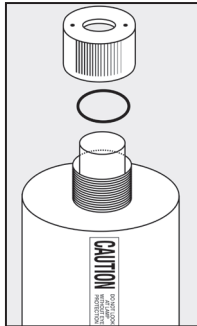

Quartz sleeve removal

Lamp changing (every year of operation) :

1. Shut valve(s) so that water cannot flow through steriliser.
2. Switch off steriliser by unplugging mains.
3. Undo end cover screws.
4. Unplug lamp connector.
5. Remove lamp very carefully.

Reverse procedure when replacing lamp, ensuring that lamp is centrally located in the chamber. Handle only by the ends.

Quartz Sleeve Cleaning :

If dirt is allowed to build up on the quartz sleeve it will impair the UV output. The quartz sleeve should be removed after one month and inspected for deposits. Clean with calcium lime and rust remover (CLR). Apply some CLR to a soft cloth and wipe the quartz sleeve. Once clean, wipe any residual CLR off with a wet soft cloth. Handle the sleeve with tissue to keep it clean. The sleeve should be cleaned every three months or as required.

Sleeve removal (use care-fragile) :



CAUTION: Handling lamp and quartz sleeve. Keep the quartz components free of finger marks to avoid loss of output through dirt or grease shadows - handle the lamps by their ends where possible. Wipe lamp and sleeve with clean cloth or tissue if needed. The o-rings should be replaced annually or if damaged – do not grease the o-rings.

1. Remove lamp as described.
2. Remove drain port cap and empty water from chamber.
3. Undo nut at top of the chamber and remove o-ring, withdraw sleeve carefully. A thin piece of dowel can be used to assist.



NOTE: When withdrawing sleeve take care not to let the end drop into the chamber as it could break.

4. Inspect o-rings for damage, replace annually.

Reverse procedure when replacing sleeve.

When replacing quartz sleeve after cleaning, the sleeve should stick out about 1cm at the top. Place o-ring over closed nut end and fit closed nut, fastening it hand tight.

A tiny amount of silicon spray or CRC in the end of aluminium endcap threads will aid easy tightening. Do not use excessive force when tightening nuts. Do not re-use quartz sleeve or o-rings if damaged.

WATER QUALITY

Where the water being pumped contains unusually high levels of dissolved solids (hard water), iron, manganese or biological organisms, a deposit build up on the quartz sleeve may occur over time. This will compromise the effectiveness of the UV system and the sleeve should be cleaned as required to maintain it in a clean condition. Discoloured water will reduce the effectiveness of the UV system and filtration should be installed.

LAMP ALARM SYSTEM

If the UV lamp is out due to a failure or bad connection the alarm buzzer will sound and the red LED will light. The alarm will disconnect power from the pump preventing untreated water from being delivered. The alarm function can be checked by switching the unit off, disconnecting the lamp and then switching the unit back on.

The lamp should be replaced after a year's running time. The alarm will beep intermittently after the internal clock has measured this time as a reminder to change the lamp. Pressing the recessed 'reset' button with a ballpoint pen will silence it for 24 hours at a time to allow time for a new lamp to be obtained. Once a new lamp is installed press the reset button for 5 seconds to start another year's timing. Do this whenever a new lamp is installed. The alarm light flashes slowly during normal operation to show the timer circuit is running.

If alarm sounds when new lamp is inserted, turn power off for five minutes to allow for internal reset of the power supply.

TROUBLESHOOTING

Torium2

- a) PUMP HAS STOPPED OR MOTOR RUNS FOR SHORT PERIOD ONLY WHEN SWITCHED ON OR PRIME BUTTON PUSHED, BUT DOES NOT PUMP.
1. Suction line and pump body not filled with water.
 2. Air leaks in suction lines or suction pipe not under water.
 3. Air trapped in suction lines (also possible with flooded suction due to uneven rise in piping; eliminate humps and hollows).
 4. No water at source or water level too low.
 5. Valve on suction lines closed. Open valve & pump will restart automatically or press "Prime" button.
- b) PUMP SWITCHES ON AND OFF FREQUENTLY (CYCLING)
1. Cycling may occasionally be caused by float valves filling tanks.
 2. Leaking taps, float valves etc. check plumbing.
 3. Leaking check valve/foot valve.
 4. Discharge plumbing has been connected to the priming port.
- c) MOTOR DOESN'T START WHEN SWITCHED ON - LOW PRESSURE INDICATOR LIGHT NOT ILLUMINATED
1. Power not connected or no power available from supply outlet.



WARNING: Automatic reset thermal overloads may allow the pump to restart without warning. Always disconnect the pump motor from the electrical supply before maintenance or repairs.



WARNING: When servicing or attending pump and/or controllers, always ensure power is switched off and lead unplugged. Electrical connections should be serviced only by qualified persons.

- d) PUMP WILL NOT STOP
1. Water leaks on discharge side of pump.

RainBank

- a) PUMP WILL NOT SWITCH OFF
1. Yellow 'manual override' button pushed in too far. Pry out the section of the yellow button that has been pushed into the RainBank housing with a small flat blade screwdriver.
 2. Water is still being used. Check all taps, toilets and appliances connected to RainBank system to ensure they are turned off.
 3. Water is leaking on discharge side of RainBank system.
 4. Rock or debris caught inside RainBank. Call your plumber to fit a Y strainer - RainBank will need to be returned to Davey.

b) PUMP WILL NOT SWITCH ON

1. Pump not plugged in. Plug pump into base of RainBank and RainBank into power supply.
2. No power supply to pump. Contact electrician and have power restored.
3. Float switch not connected to RainBank. Plug float lead into base of RainBank. The connection port is located next to the power lead coming from the RainBank. To confirm the connection is correct, depress yellow button, pump will start.
4. No water in tank. Check water level in tank.
5. Float switch located at water tank is installed incorrectly.
6. Mains water supply not connected to RainBank. RainBank system must have a pressurised water supply connected to inlet. Press yellow "manual override" button to simulate mains water flowing.
7. Mains supply to RainBank turned off. Turn on mains water supply.
8. Pump is faulty. To confirm if the fault is within the pump, plug the pump directly into power point and check to see if it starts. If the pump starts plug the pump back into the RainBank® and continue fault finding. If the pump does not start contact your supplier for further advice.
9. Lead from float switch to pump broken or damaged. Replace float and lead assembly.
10. Float switch defective. Contact your supplier for further advice.
11. Check power to the Steriflo control box. Lamp may need to be replaced – required yearly.

c) OTHER SYMPTOMS

Mains water is still in use when pump is running.

Possible cause - pump needs to be primed. Remove priming plug from front top of pump (right above water inlet) and allow all air to escape from pump. Replace the priming plug when water dribbles out of hole.

Mains water is still in use when pump is running.

Possible cause - pump impeller blocked. Have pump serviced. Fit first flush devices and Y strainer to pipework.

Mains water not passing through RainBank.

Possible cause - debris is blocking inlet to RainBank. Remove RainBank and clean inlet.

Pump hums.

Possible cause - pump is jammed or seized. Have pump serviced.

Steriflo

Principle. A ballast (choke) provides the correct voltage and current for the lamp(s). The circuit board monitors the current to the lamp and if it is not present, illuminates the red alarm light and sounds the alarm buzzer (a “squealing” noise). An orange light indicates the power is on.

- a) UV LAMP OUT, NO ORANGE “ON” LIGHT, NO ALARM
 - 1. No mains voltage.
 - 2. Internal fuse failed.
 - 3. Check mains power connections inside power supply.
- b) UV LAMP FLICKERING, ALARM ON
 - 1. Failed lamp.
 - 2. Incorrect lamp or ballast fitted.
- c) UV LAMP OUT, ALARM ON
 - 1. Lamp failed.
 - 2. Poor connection to lamp (check/clean connector/lamp pins).
 - 3. Ballast failed (unlikely).
- d) LAMP ON, ALARM ON
 - 1. Faulty circuit board.
- e) LAMP OUT, ALARM OFF
 - 1. Loose connection or faulty circuit board, possibly short in lamp circuit.



WARNING: When servicing or attending your Steriflo, always ensure power is switched off and lead unplugged. Electrical connections should be serviced only by qualified persons. If the supply cord is damaged, it must be replaced by the manufacturer, its service agent or similarly qualified persons in order to avoid a hazard.



Care should also be taken when servicing or disassembling the unit and associated pipework to avoid possible injury from pressurised water. Unplug power, relieve pressure by opening a tap on the discharge side of the unit and allow any water in the unit to cool before attempting to dismantle.

Part Numbers

- a) Lamp
GPH550N2/W
- b) Sleeve
TT600
- c) O-rings
All models S24x3N70 (2 per sleeve)



WARNING
ULTRA-VIOLET RADIATION IS HARMFUL TO SKIN AND EYES.

EYES

Switch off UV system before removing covers. If working within line of sight of UV light, ensure that a suitable full face plastic facemask is worn.

SKIN

It is recommended that exposed skin is covered to prevent sunburn, possibly severe, if working within line of sight of operating UV system. Note: exposure to UV light results in symptoms that develop slowly, the exposure cannot be felt at the time.

SYMPTOMS

EYES: Mild exposure - irritation developing several hours later.
Severe exposure - sore, red eyes, sensitive to light, painful to keep eyes open.

SKIN: Mild exposure - slight reddening, tenderness, mild sunburn symptoms.
Severe exposure - skin sloughing (peeling), weeping area, severe sunburn symptoms.

FIRST AID

EYES: In mild cases, if in doubt seek medical attention.
Severe cases cover eyes with gauze or clean cloth, seek medical attention.

SKIN: In mild cases removal from exposure may be sufficient. If in doubt seek medical attention.
In severe cases, cover affected area loosely with a clean bandage or cloth. Seek medical attention. Do not apply fat, butter or oil to skin.

The above notes are intended to highlight the dangers of exposure to UV radiation. With sensible precautions any hazard can be eliminated. Germicidal UV cannot pass through clothing or other opaque materials or clear materials such as plastics or even window glass.



During service **DO NOT** use lubricants or sealants of any type on the o-rings. Keep the inside of the quartz sleeve dry and clean.



WARNING - Do not use hydrocarbon based or hydrocarbon propelled sprays around the electrical components of this unit.

Repair or Replacement Guarantee

In the unlikely event in Australia or New Zealand that this product develops any malfunction within warranty periods beginning from the date of original purchase due to faulty materials or manufacture, We will at our option repair or replace it for you free of charge, subject to the conditions below.

Aquashield MAX Guarantee Period

Rainbank - Three Years
Steriflo Lamp - Six months

Torium2 Controller - Two Years
Steriflo Controller - One Year

Pump - Two Years
Microlene Cartridge - One Year

Should you experience any difficulties with your product, we suggest in the first instance that you contact the Dealer from which you purchased the product. Alternatively you can phone our Customer Service line on 1300 367 866 in Australia, or 0800 654 333 in New Zealand. On receipt of your claim, we will seek to resolve your difficulties or, if the product is faulty or defective, advise you on how to have your product repaired, obtain a replacement or a refund.

Your Guarantee naturally does not cover normal wear or tear, replacement of product consumables (i.e. mechanical seals, bearings or capacitors), loss or damage resulting from misuse or negligent handling, improper use for which the product was not designed or advertised, failure to properly follow the provided installation and operating instructions, failure to carry out maintenance, corrosive or abrasive water or other liquid, lightning or high voltage spikes, or unauthorized persons attempting repairs. Where applicable, your Davey product must only be connected to the voltage shown on the nameplate.

Your Guarantee does not cover freight or any other costs incurred in making a claim. Please retain your receipt as proof of purchase; you **MUST** provide evidence of the date of original purchase when claiming under the Guarantee.

Davey shall not be liable for any loss of profits or any consequential, indirect or special loss, damage or injury of any kind whatsoever arising directly or indirectly from Microlene products. This limitation does not apply to any liability of Davey for failure to comply with a consumer guarantee applicable to your product under the Australian or New Zealand legislation and does not affect any rights or remedies that may be available to you under the Australian or New Zealand Consumer Legislation.

In Australia, you are entitled to a replacement or refund for a major failure and for compensation for any other reasonably foreseeable loss or damage. You are also entitled to have the goods repaired or replaced if the goods fail to be of acceptable quality and the failure does not amount to a major failure.

Should your product require repair or service after the guarantee period; contact your nearest Dealer or phone the our Support Centre on the number listed below.

For a complete list of our Dealers visit our website (microlene.com.au) or call:



Davey Water Products Pty Ltd
Member of the GUD Group
ABN 18 066 327 517

AUSTRALIA

Customer Service Centre

6 Lakeview Drive,
Scoresby, Australia 3179
Ph: 1300 232 839
Fax: 1300 369 119
Email: sales@davey.com.au
Website: davey.com.au

NEW ZEALAND

Customer Service Centre

7 Rockridge Avenue,
Penrose, Auckland 1061
Ph: 0800 654 333
Fax: 0800 654 334
Email: sales@dwpc.co.nz
Website: daveynz.co.nz

© Davey is a registered trademark of Davey Water Products Pty Ltd. © Davey Water Products Pty Ltd 2017.



Davey Water Products Pty Ltd
Member of the GUD Group
ABN 18 066 327 517

AUSTRALIA

Customer Service Centre

6 Lakeview Drive,
Scoresby, Australia 3179
Ph: 1300 232 839
Fax: 1300 369 119
Email: sales@davey.com.au
Website: davey.com.au

NEW ZEALAND

Customer Service Centre

7 Rockridge Avenue,
Penrose, Auckland 1061
Ph: 0800 654 333
Fax: 0800 654 334
Email: sales@dwp.co.nz
Website: daveynz.co.nz